

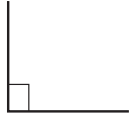

Acute and obtuse angles

A right angle forms a square corner.



An obtuse angle is greater than a right angle.

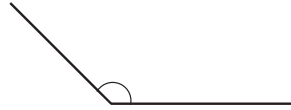

An acute angle is less than a right angle.

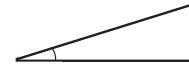

Look at these angles.

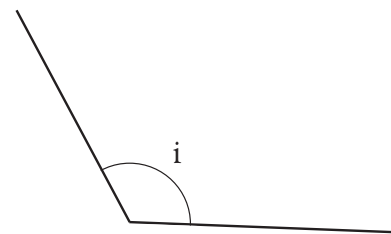
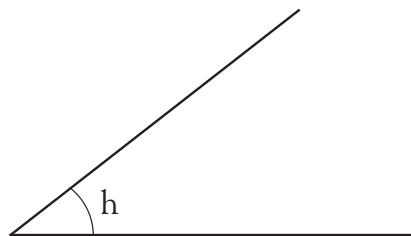
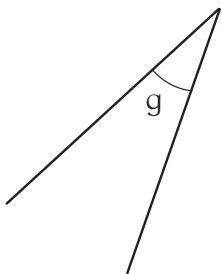
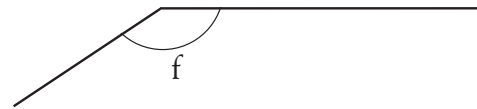
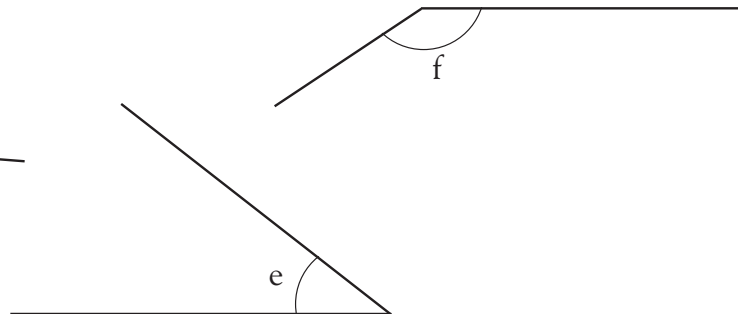
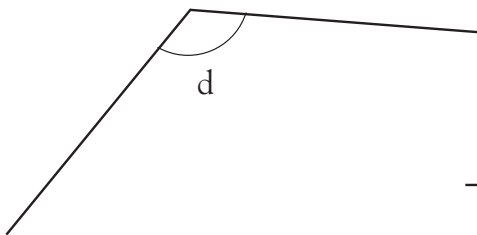
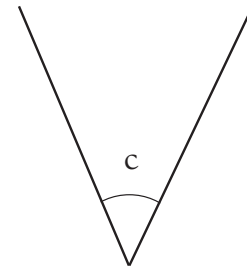
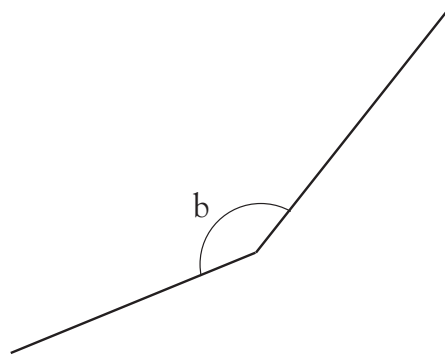
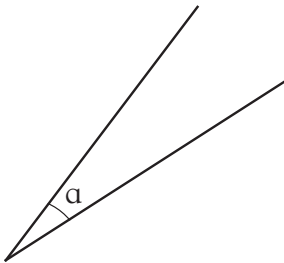

Which of the angles are acute?

Which of the angles are obtuse?



Acute and obtuse angles

A right angle forms a square corner.

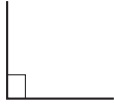

An obtuse angle is greater than a right angle.

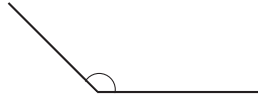

An acute angle is less than a right angle.

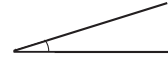

Look at these angles.

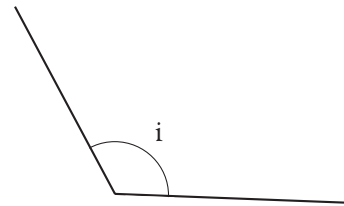
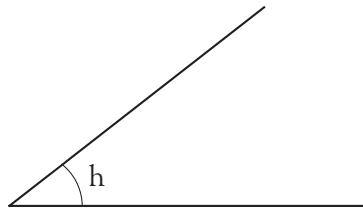
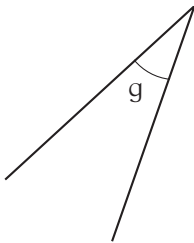
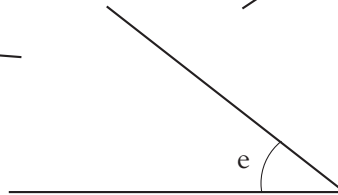
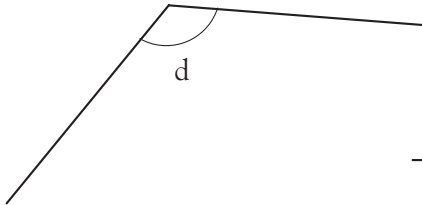
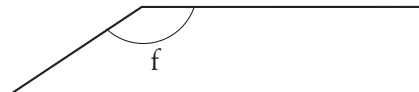
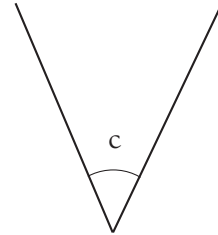
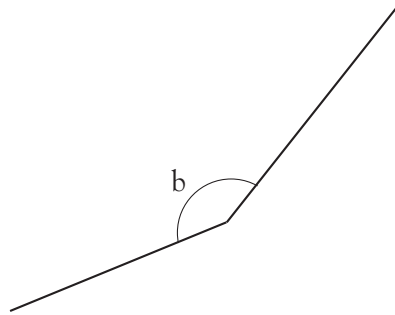
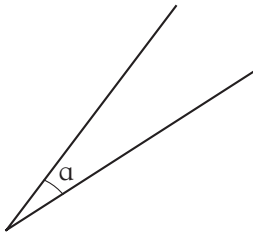

Which of the angles are acute?

a, c, e, g, h

Which of the angles are obtuse?

b, d, f, i

Children should have no difficulty identifying each angle if they compare it to a right angle.